

Portable Surface Roughness Tester Surftest SJ-220

Form Measurement



Intuitive Usability, Great Scalability

A portable surface roughness tester designed like a hand tool for easy on-site use

The SJ-200 series of portable surface roughness measuring instruments, which has contributed to industrial development and technological progress through precision measurements, has evolved further still.

While maintaining excellent portability and ease of use on-site, it now also provides touch screen functionality for intuitive operability.

Equipped with a built-in battery, it can perform measurements even in environments where power is not available and can be used approximately 1000 times on a full charge.

Cableless and paperless work is also made possible by using the Wireless Unit for Measuring Instrument U-WAVE-TIB.

This is a user-friendly device that provides compatibility and versatility to meet the diverse needs of manufacturing sites.

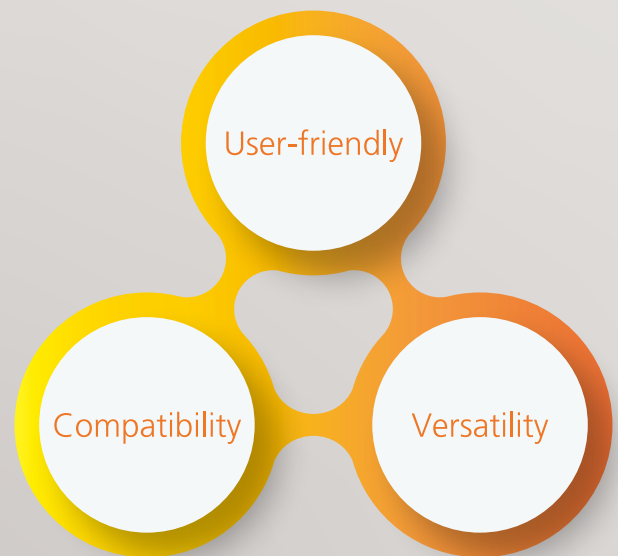

Use the QR code to access a demonstration video.





Actual size

User-friendly



Simple and easy for anyone to use. Convenient portability and one-touch measurement functionality have been updated for comfortable operability.

Measurements can be taken on-site, so there is no need to transport large and heavy workpieces. Light and compact, the device is easy to carry and allows for simple one-touch measurement. Furthermore, the large, easy-to-read display supports touch operation, allowing for intuitive and smooth measurement. It also includes functions such as disabling the touch screen and setting shortcuts using the Home key.



Its versatility makes it suitable for a variety of measurement situations.



Intuitive operation through touch screen

The device is equipped with a touch screen and a new user interface. You can perform operations like changing the display screen and adjusting the settings with your fingertip. In addition to touch operations, it also supports flick and swipe operations, making it easy for anyone to perform measuring work. You can also disable touch screen operation by holding down the PAGE key.

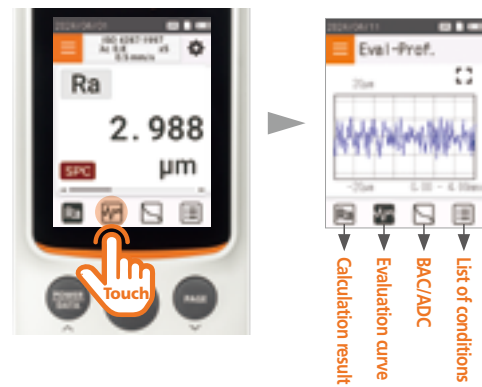

Large display is easy to see and use

The screen size has been expanded to 2.8 inches, achieving high visibility while maintaining a compact device size to fit in one hand. The backlight makes it clear and easy to see even in dimly lit locations. You can also change the screen display orientation.

Vertical screen display



Horizontal screen display



Includes buttons in addition to the touch screen, for further accessibility

Even if you are wearing gloves and unable to operate the touch screen, you can still operate with using the physical buttons. With the addition of the Home key, you can jump to the Home screen with one touch, display the daily menu, and call up calibration measurements and measurement conditions.

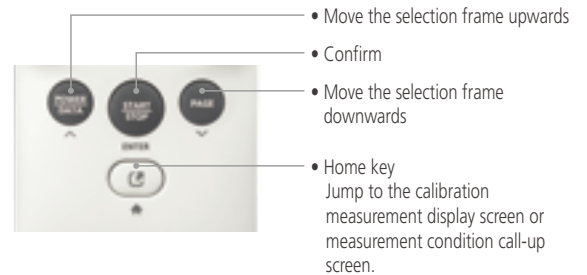

Drive unit selection

See page 10 for details.



Use the QR code to access an introductory video on each drive unit.

Standard drive unit type

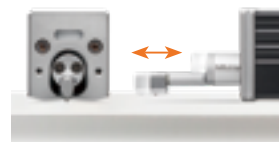

Retractable drive unit type

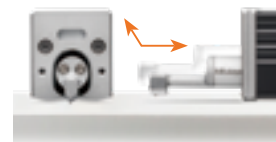

Transverse tracing drive unit type



Battery powered to enable measurement anywhere

Equipped with a built-in battery, it can perform measurements even in environments where power is not available. On a full charge, it can be used to perform measurement approximately 1000 times.

Compatible with new standard ISO 21920

In addition to conventional roughness standards, it supports the new surface texture standard ISO 21920.

JIS B 0601:1982	JIS B 0631:2000
ISO 21920:2021	JIS B 0601:1994
ISO 4287:1997	ASME B46.1
JIS B 0601:2013	ISO 13565:1996
VDA2006	JIS B 0671:2002
ISO 12085:1996	

Supports 25 languages

In this model, we have added Thai, Vietnamese, Indonesian, and Malay to the number of languages supported, making it a multilingual device for use in 25 languages. You can easily switch languages from the Home screen. Additionally, the accompanying CD-ROM includes a user's manual in 3 languages (Japanese, English, and Chinese).

Japanese	English*	German	French
Italian	Spanish	Portuguese	Korean
Traditional Chinese	Simplified Chinese	Czech	Polish
Hungarian	Turkish	Swedish	Dutch
Slovenian	Russian	Romanian	Bulgarian
Finnish	Thai	Vietnamese	Indonesian
Malay			

*Settings at time of purchase

Compatibility

Connectable and convenient.
High-speed transmission of
measurement data.
Significantly strengthened
communication functions.



As an option, the Wireless Unit for Measuring Instrument U-WAVE-TIB, which enables Bluetooth® communication, is available. Bidirectional communication is now possible without the need to connect a cable.

By connecting to a smartphone or PC, you can further improve the efficiency of measurement work.

Of course, USB communication and RS-232C communication are also still possible.

You can build a communication environment to suit the on-site circumstances.

Equipped with various input/output ports as standard equipment



Use the QR code to access a demonstration video.



Increased measuring efficiency. Displaying measurement results, setting measurement conditions, and bidirectional communication are also possible.

"Wireless Unit for Measuring Instrument U-WAVE-TIB"

By attaching the optional wireless communication unit, it is possible to have wireless communication via Bluetooth® with a device (PC or smartphone) on which the dedicated app* is installed.

In addition to receiving measurement results, the terminal side can also send measurement condition settings and measurement start information, allowing for cableless measurement work.

*"SJ-App" (for smartphones [Android 12 or later]), "SJ-Communication-Tool" (for PC [Windows 10/11]): See pages 8-9 for details.



USB communication for sending and receiving measurement data

Bidirectional communication is possible by connecting the SJ-220 to a PC with a USB cable and installing the dedicated app "SJ-Communication-Tool".

Measurement work can be made more efficient by setting measurement conditions on the PC.

*The USB connector also serves as a charging port.

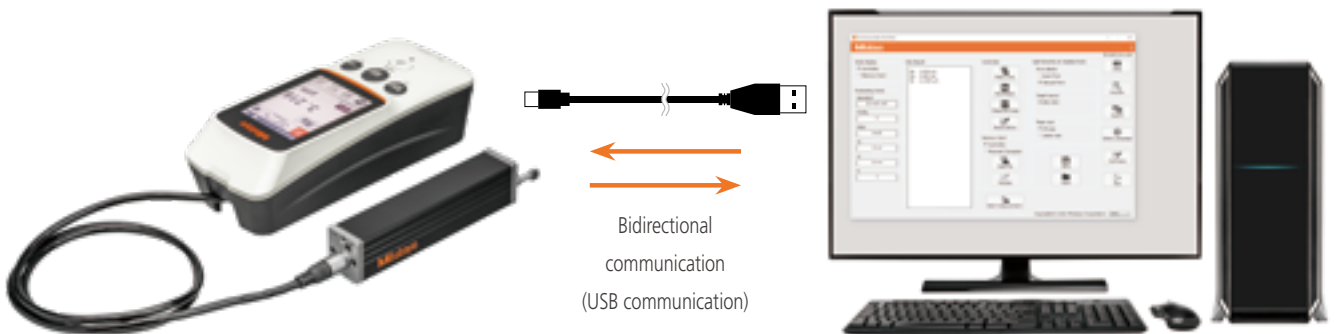

Compatible with digimatic interface

SPC output of measurement results is possible by connecting to an optional Digimatic Mini Processor using the Digimatic Connection Cable.

It also has an automatic digimatic output function.*

*The SJ series can only output results for one roughness parameter.



Versatility

Expand functionality by linking with a smartphone, etc.



We provide "SJ-App" and "SJ-Communication-Tool" as dedicated apps to expand remote operation and the scope of measurement result utilization.

By installing the optional Wireless Unit for Measuring Instrument U-WAVE-TIB, it can be linked with a smartphone, etc., supporting expanded functionality and efficient measurement.

The dedicated apps can be downloaded free from the Mitutoyo website.

Dedicated app "SJ-App" for increased efficiency of measurement work

The dedicated app that enables communication with the SJ-220 is equipped with various functions to increase work efficiency. It is also possible to manage data, create inspection reports, and export to CSV and PDF files on the terminal.

Smartphone icon display



*Example

Startup screen



Calculation result



Inspection report



App



Dedicated smartphone app
"SJ-App"

Freely
available



Can be downloaded from the Mitutoyo website.

■ Download site URL
<https://www2.mitutoyo.co.jp/eng/contact/products/SJ-App/>
 Android 12 or later, Bluetooth® 5.0 compatible (Android only)

Added convenience by linking to PC with highly functional free software, "SJ-Communication-Tool"

We provide free software that allows you to import various data (measurement conditions, parameter settings, calculation results, measurement data) from the SJ-220 to create and edit inspection reports on your PC. This software can reduce to your creating report time significantly.

Confirmed operation environments

- OS: Windows 10 (64 bit), Windows 11 (64 bit)
- * Windows is a product of Microsoft Corporation.
- * Connection requires a USB 2.0 Cable or a Wireless Unit for Measuring Instrument U-WAVE-T1B

Software



PC-linked software
"SJ-Communication-Tool"

Freely
available



Can be downloaded from the Mitutoyo website.

■ Download site URL
<https://www2.mitutoyo.co.jp/eng/contact/products/SJ-Communication-Tool/>
 Windows 10/11, Bluetooth® 5.0 compatible (Windows only)

Utilization of QR codes

A QR code can be displayed on the inspection report and used for data management such as the following.

- Linking with measurement data
- Recalling saved measurement data



"FORMTRACEPAK-AP" to support advanced analysis

It is possible to perform more advanced analysis by loading the SJ-220 measurement data into the analysis program "FORMTRACEPAK-AP" for evaluation type surface roughness/contour measuring devices.



Using "MeasurLink" to achieve quality visualization

By using "MeasurLink", data from measurement devices connected to the network can be collected and centrally managed in real time. Statistical processing can be performed to achieve visualization of quality.

MeasurLink[®]

Use the QR code to access a demonstration video.



*MeasurLink[®] is a registered trademark of Mitutoyo Corporation in Japan and Mitutoyo America Corporation in the United States.

Functional Introduction for Each Drive Unit Type

Detectors and drive units for conventional devices can be used. Detectors can be easily replaced. (See page 15 for details on detector types.)



Use the QR code to access an introductory video on each drive unit.

Standard Drive Unit Type

Measurement length 16 mm

- Can be connected to the SJ-220, SJ-210, and SJ-310 detectors and calculation display units.
- The Standard drive unit is our bestselling drive unit type.

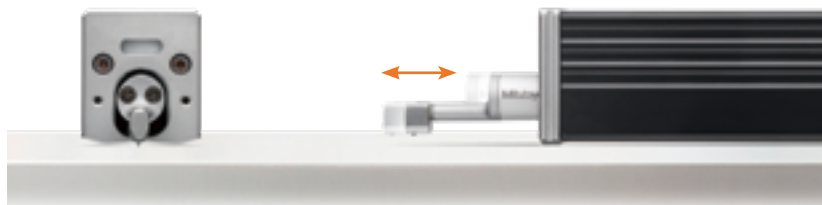

Retractable Drive Unit Type

Measurement length 16 mm

Amount of retraction 1 mm

- By retracting the detector upward in advance, it is possible to place the tester without the detector coming into contact with the workpiece.
- Helps avoid damage to the detector when mounting jigs or installing automatic measuring equipment.

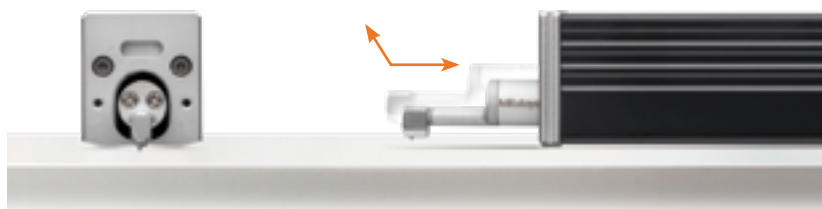

Transverse Tracing Drive Unit Type

Measurement length 5.6 mm

- Lateral movement of the detector enables axial measurement of roughness for crankshafts, etc.
- Suitable for measuring narrow areas such as wire electrical discharge machining surfaces.



Example of Combination with Height Gage

When used in combination with a Height Gage, a variety of measurements can be performed.



Use the QR code to access a demonstration video.



Optional Accessories

Nosepiece for Flat Surfaces

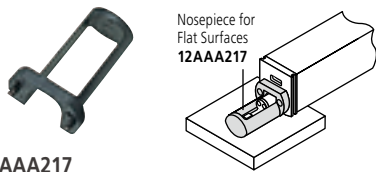

12AAA217
Note: Not available for the Transverse tracing drive unit.

Nosepiece for Cylindrical Surfaces



12AAA218
Note: Not available for the Transverse tracing drive unit.

Support Feet Set

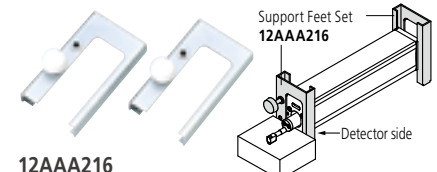

12AAA216
Note: Not attachable to the detector side of the Transverse tracing drive unit.

V-type Adapter

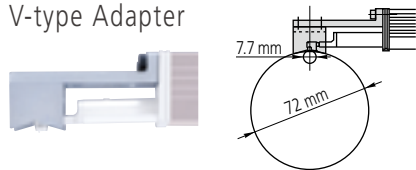

12AAE644
Note 1: Transverse tracing type standard accessory.
Note 2: Dedicated to the Transverse tracing drive unit.

Point-contact Adapter

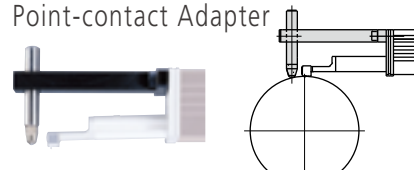

12AAE643
Note 1: Transverse tracing type standard accessory.
Note 2: Dedicated to the Transverse tracing drive unit.

Extension Rod (50 mm)

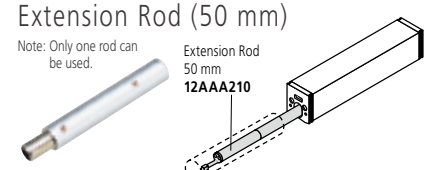

12AAA210
Note: Only one rod can be used.
Note: Not available for the Transverse tracing drive unit.

Vertical Positioning Adapter

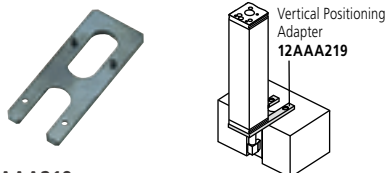

12AAA219
Note: Not available for the Transverse tracing drive unit.

Height Gage Adapter

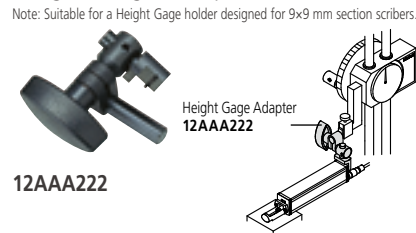

Note: Suitable for a Height Gage holder designed for 9x9 mm section scribers.

12AAA222

Magnetic Stand Adapter

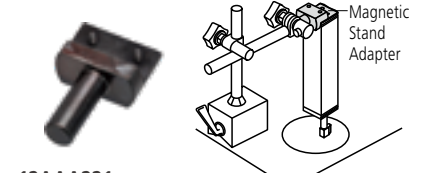

12AAA221
(Mounting spigot diameter is 8 mm)

Roughness Specimen W

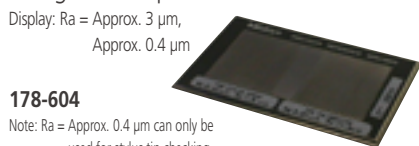

178-604
Note: Ra = Approx. 0.4 μ m can only be used for stylus tip checking.

Extension Cable (1 m)



12BAA303
Note: Only one cable can be used.
Note: For connecting calculation display unit and drive unit.



12AAA220
(Mounting spigot diameter is 9.5 mm)

Foot Switch



12AAJ088

RS-232C Communication Cable



12AAY688

USB Input Tool Direct (2 m) USB-ITN-SF



06AGQ001F

Digimatic Mini Processor DP-1VA LOGGER



264-505

Connection Cable (1m)

06AGL011

Connection Cable (2m)

06AGL021



Memory Card



12AAY917
Note 1: microSD card (with an adapter to SD card)
Note 2: Not all memory cards can be recognized. Please use the optional SD memory card.

Specifications

Type of detector	Standard drive unit type		Retractable drive unit type		Transverse tracing drive unit type		
Model No.	SJ-220 (0.75 mN type)	SJ-220 (4 mN type)	SJ-220 (0.75 mN type)	SJ-220 (4 mN type)	SJ-220 (0.75 mN type)	SJ-220 (4 mN type)	
Order No.	mm	178-741-11	178-742-11	178-743-11	178-744-11	178-745-11	
	inch/mm	178-741-13	178-742-13	178-743-13	178-744-13	178-746-13	
Measuring range	Traverse length ^{*1}	17.5 mm				5.6 mm	
	Detector	Range	360 μm (-200 μm to +160 μm)				
		Range/resolution	AUTO / depending on the measurement range, 360 μm/3.5 nm, 100 μm/0.9 nm, 25 μm/0.2 nm				
Tracing speed	During measurement: 0.25 mm/s, 0.5 mm/s, 0.75 mm/s, 1 mm/s				During return: 1 mm/s		
Measuring force		0.75 mN	4 mN	0.75 mN	4 mN	4 mN	
Stylus tip	Radius	2 μm	5 μm	2 μm	5 μm	5 μm	
	Angle	60°	90°	60°	90°	90°	
Skid force	Less than 400 mN						
Applicable standards	JIS B 0601:1982, JIS B 0601:1994, JIS B 0601:2013, JIS B 0671:2002, JIS B 0631:2000, ISO 4287:1997, ISO 13565:1996, ISO 12085:1996, ISO 21920:2021, ASME B46.1, VDA2006						
Assessed profiles	Primary profile (P), Roughness profile (R), DF profile, R-Motif						
Parameters	Refer to page 13						
Filters	2CR75 / PC75 / Gaussian						
Cut-off length	λ c	0.08, 0.25, 0.8, 2.5, 8 mm				0.08, 0.25, 0.8, 2.5 mm	
	λ s ^{*2}	2.5/NON, 2.5/NON, 2.5/NON, 8/NON, 8/25/NON (μm)				2.5/NON, 2.5/NON, 2.5/NON, 8/NON (μm)	
Sampling length	0.08, 0.25, 0.8, 2.5, 8 mm				0.08, 0.25, 0.8, 2.5 mm		
Number of sampling lengths	x1, x2, x3, x4, x5, x6, x7, x8, x9, x10, Arbitrary (0.1 to 16.0 mm / 0.01 mm interval)		x1, x2, x3, x4, x5, x6, x7, x8, x9, x10, Arbitrary (0.3 to 16.0 mm / 0.01 mm interval)		x1, x2, x3, x4, x5, x6, x7, x8, x9, x10, Arbitrary (0.1 to 5.6 mm / 0.01 mm interval)		
LCD specifications	2.8" TFT color LCD touch panel with a backlight (320x240dot) Touch screen functions: Touch, swipe, flick, long press Backlight functions: Backlight adjustment (from 5 levels), ECO mode (The backlight turns off if the touch screen is not operated for 10 seconds)						
Display languages	25 languages (Japanese, English, German, French, Italian, Spanish, Portuguese, Korean, Traditional Chinese, Simplified Chinese, Czech, Polish, Hungarian, Turkish, Swedish, Dutch, Russian, Slovenian, Romanian, Bulgarian, Finnish, Thai, Vietnamese, Indonesian, and Malay)						
Measurement result display	The number of calculation results and display orientations can be switched depending on the application. For trace display, the most recent 10 calculation results for a parameter can be displayed. Vertical display: 1-step display / 3-step display / trace display Horizontal display: 1-step display / 4-step display / trace display *The horizontal display is invertible left-right.						
Printing function	If an optional RS-232C cable and a thermal printer are used, measurement conditions, calculation results, calculation results for each sampling length, a measurement profile, and BAC/ADC profiles can be printed. (Print scale: Horizontal: x1 to x1K/AUTO, Vertical: x10 to x100K/AUTO)						
External I/O	USB I/F (Type-C) / Digimatic output / RS-232C I/F / Foot SW I/F / BLE I/F *Digimatic and RS-232C and BLE cannot be used parallelly.						
GO/NG judgment	Max value / 16% rule / Mean rule (Only "Mean rule" can be selected in ASME. "16% rule" cannot be selected in VDA)						
	Storage	<ul style="list-style-type: none"> 10 sets of measurement conditions and 1 measurement result can be stored in the display unit. microSD card (optional): 500 sets of measurement conditions, 10000 sets of measurement results, 500 sets of image data, txt file (measurement conditions, measurement data, evaluation profile, BAC, ADC) 					
	Calibration	Ra calibration / Average calibration can be performed with multiple measurements (Max.5 times).					
Functions	<ol style="list-style-type: none"> Data key allocation function: outputs Digimatic data, saves measurement data, prints with an external printer, and saves / screen a screen shot. Stylus alarm function: informs an operator that the cumulative measuring distance exceeds the preset threshold. Auto-save function: allows measurement data to be automatically saved after measurement. Recalculation function (This function may not be available under certain measurement conditions, for example, for λc) Displayed evaluation curves can be zoomed in/out. Function restriction: Access to certain functions can be limited by password setting. Self-timer: Measurement start can be delayed for a set length of time. Calendar function: A data and time can be set. Volume control function: The key operation sound can be adjusted at 5 levels and can be turned off. Function to detect detector connection Hard copy function (Bitmap data can be pasted) 						
	Useful functions						
Hardware key specifications	[POWER/DATA] key (Power-on, data output. Long press: power-off) [START/STOP] key (Measurement start and stop) [PAGE] key (Page feed. Long press: Disabling the touch panel) [HOME] key (Return to the HOME screen. Display the [Daily menu] screen)						
Power saving function	Auto-OFF function (Standby time can be arbitrarily set from 10 to 600 seconds. The Auto-OFF function is disabled when the AC adaptor is used)						
Power supply	AC adaptor (USB type with interchangeable AC pin adapters), Input voltage: 100 VAC to 240 VAC ±10 % (50 Hz / 60 Hz) Output rating: 5.0 VDC/2.0 A, Internal battery (Ni-MH), USB standard supported: USB 2.0 (Full speed), USB charging standard: BC1.2 The following USB ports are supported: SDP "SDP (Standard Downstream Port)", CDP "CDP (Charging Downstream Port)", DCP "DCP (Dedicated Charging Port)"						
Built-in battery	Charging time: Up to 4 hours (operable during charging) * The charging time above is applied when the supplied AC adaptor is used. When the battery is charged via a USB connection with a PC, etc., charging may take more than 4 hours to complete. Number of measurable times: Approx. 1,000 times (depending on the measurement conditions with full charge) Charging temperature : 5°C to 40°C * If the ambient temperature is too high, the battery may not charge sufficiently.						
Size (W × D × H)	Display unit	164.7×67.1×51.9 mm					
	Drive unit	115×23×26 mm					
Mass	330 g (Display unit), 180 g (Drive unit), 7.8 g (Detector)						
Standard accessories	12AA583 : Handy Case 12BA303 : Connecting Cable 12BA540 : AC Adaptor 12BA541 : USB2.0 Cable 178-601-1 : Roughness Specimen (mm) / (178-602-1 : inch/mm) 12BAK700 : Calibration Stage 12BAS476 : Tool for Operating The Internal Battery Switch Manual Documentations Warranty				12AA583 : Handy Case 12BA303 : Connecting Cable 12BA540 : AC Adaptor 12BA541 : USB2.0 Cable 178-605 : Roughness Specimen (mm) / (178-606 : inch/mm) 12BAK700 : Calibration Stage 12BAS476 : Tool for Operating The Internal Battery Switch 12AAE643 : Point-contact Adaptor 12AAE644 : V-type Adaptor Manual Documentations Warranty		

*1: Including pre-travel / post-travel *2: λs cannot be selected depending on the selected standard.

Applicable Standards and Parameters

Roughness standard	Evaluation profile	Parameters
JIS B 0601:1982	P	Rz, Rmax
	R	Ra
JIS B 0601:1994	R	Ra, Rz, Ry, Pc, Sm, S, mr(c)
JIS B 0601:2013	P	Pa, Pq, Pz, Pp, Pv, Pt, Psk, Pku, Pc, PSm, PzJIS, P Δ q, Pmr, Pmr(c), P δ c, Rk, Rpk, Rvk, Mr1, Mr2, A1, A2
	R	Ra, Rq, Rz, Rp, Rv, Rt, Rsk, Rku, Rc, RSm, RzJIS, R Δ q, Rmr, Rmr(c), R δ c, Rk, Rpk, Rvk, Mr1, Mr2, A1, A2
JIS B 0671:2002	DF	Ra, Rq, Rz, Rp, Rv, Rt, Rsk, Rku, Rc, RSm, RzJIS, R Δ q, Rmr, Rmr(c), R δ c, Rk, Rpk, Rvk, Mr1, Mr2, A1, A2
JIS B 0631:2000	R-Motif	R, Rx, AR
ISO 4287:1997	P	Pa, Pq, Pz, Pp, Pv, Pt, Psk, Pku, Pc, PPC, PSm, Pz1max, P Δ q, Pmr, Pmr(c), P δ c, Rk, Rpk, Rvk, Mr1, Mr2, A1, A2
	R	Ra, Rq, Rz, Rp, Rv, Rt, Rsk, Rku, RPC, Rc, RSm, Rz1max, R Δ q, Rmr, Rmr(c), R δ c, Rk, Rpk, Rvk, Mr1, Mr2, A1, A2
ISO 13565-1:1996 ISO 13565-2:1996	DF	Ra, Rq, Rz, Rp, Rv, Rt, Rsk, Rku, Rc, RPC, RSm, Rz1max, R Δ q, Rmr, Rmr(c), R δ c, Rk, Rpk, Rvk, Mr1, Mr2, A1, A2
ISO 12085:1996	R-Motif	R, Rx, AR
ASME B46.1:2009	R	Ra, Rq, Rz, Rp, Rv, Rt, Rsk, Rku, RPC, RSm, Rmax, R Δ a, R Δ q, tp, Htp, Rpm
VDA2006	P	Pa, Pq, Pz, Pp, Pv, Pt, Psk, Pku, Pc, PSm, Pmax, P Δ q, Pmr, Pmr(c), P δ c, Rk, Rpk, Rvk, Mr1, Mr2, A1, A2
	R	Ra, Rq, Rz, Rp, Rv, Rt, Rsk, Rku, Rc, RSm, Rmax, R Δ q, Rmr, Rmr(c), R δ c, Rk, Rpk, Rvk, Mr1, Mr2, A1, A2
	DF	Ra, Rq, Rz, Rp, Rv, Rt, Rsk, Rku, Rc, RSm, Rmax, R Δ q, Rmr, Rmr(c), R δ c, Rk, Rpk, Rvk, Mr1, Mr2, A1, A2
Free	P	Pa, Pq, Pz, Py, Pp, Pv, P3z, Psk, Pku, Pc, PPC, PSm, S, HSC, PzJIS, Pppi, P Δ a, P Δ q, Plr, Pmr, Pmr(c), P δ c, Pt, Ppm, Rk, Rpk, Rvk, Mr1, Mr2, A1, A2, Vo
	R	Ra, Rq, Rz, Ry, Rp, Rv, R3Z, Rsk, Rku, Rc, RPC, RSm, S, HSC, RzJIS, Rppi, R Δ a, R Δ q, Rlr, Rmr, Rmr(c), R δ c, Rt, Rpm, Rk, Rpk, Rvk, Mr1, Mr2, A1, A2, Vo
	DF	Ra, Rq, Rz, Ry, Rp, Rv, R3Z, Rsk, Rku, Rc, RPC, RSm, S, HSC, RzJIS, Rppi, R Δ a, R Δ q, Rlr, Rmr, Rmr(c), R δ c, Rt, Rpm, Rk, Rpk, Rvk, Mr1, Mr2, A1, A2, Vo
	R-Motif	R, Rx, AR
ISO 21920:2021	ISO4287.P	Pa, Pq, Pz, Pp, Ppt, Pv, Pt, Pvt, Pzx(l), Psk, Pku, Pc, Pcx, Pcq, Ppc, PSm, PSmx, PSmq, Pda, Pdq, Pdt, Pdl, Pdr
	ISO4287.R	Ra, Rq, Rz, Rp, Rpt, Rv, Rt, Rvt, Rzx(l), Rsk, Rku, Rc, Rcx, Rcq, Rpc, RSm, RSmx, RSmq, Rda, Rdq, Rdt, Rdl, Rdr

Standard Accessories

Handy Case

12AAY583

- A case for protecting, storing, and transporting the SJ-220 main unit and accessories.
- The handy case has a charging hole that allows you to charge the SJ-220 while it is in the case.



AC Adaptor

12BAS450



Roughness Specimen (mm)

178-601-1

Roughness Specimen (inch/mm)

178-602-1



USB2.0 Cable

12BAS451

- Enables power supply and bidirectional communication



Dimensions

Drive unit stored inside display unit (Standard detector installed in drive unit)

Unit: mm

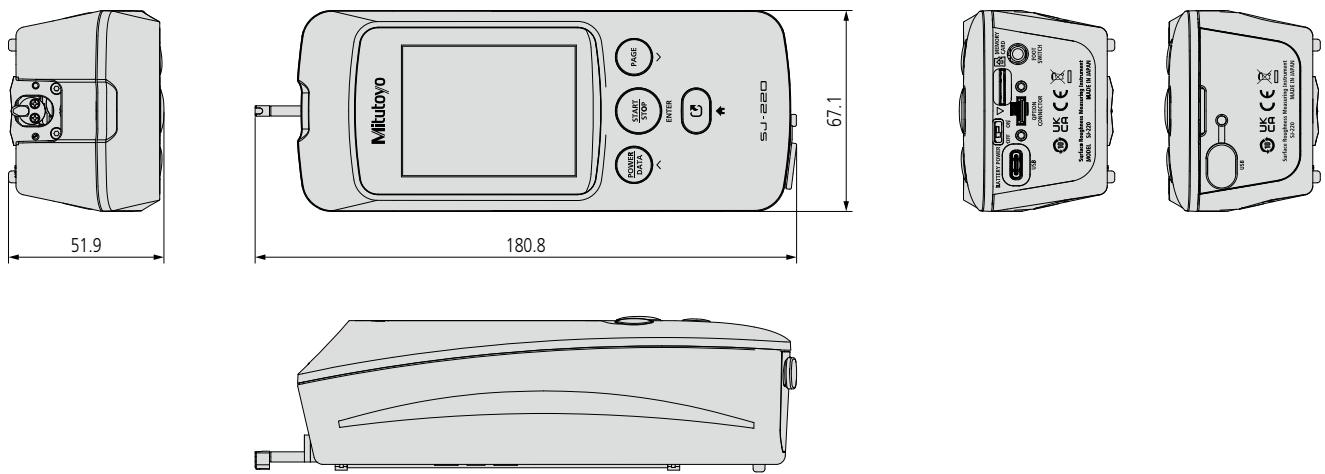

Drive unit not stored inside display unit (Standard detector installed in drive unit)

Unit: mm

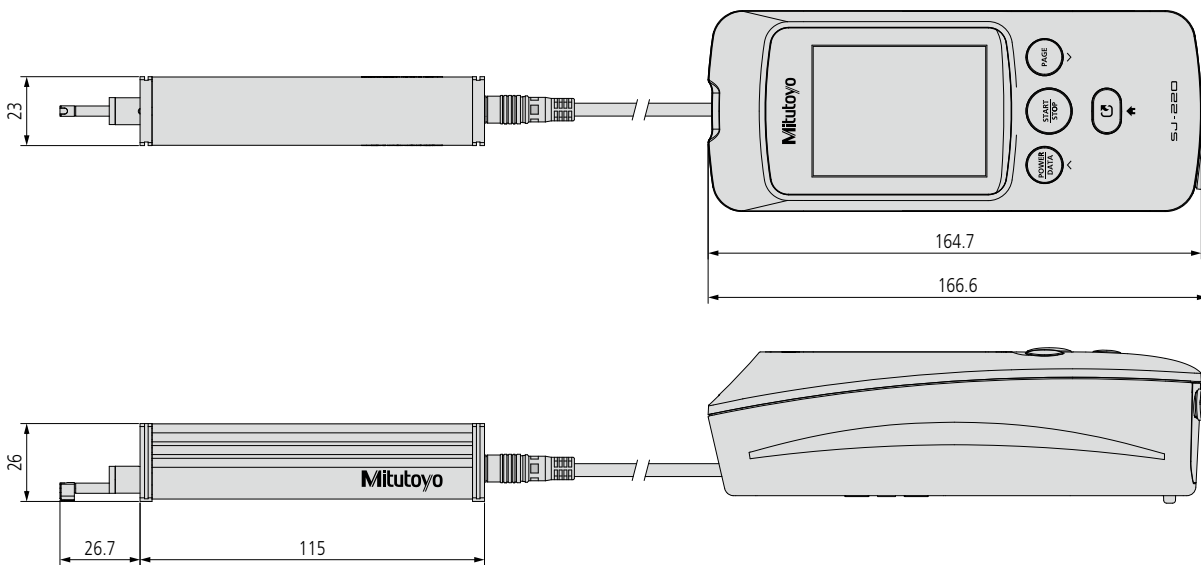

Drive unit attached with detector

Unit: mm

Standard drive unit with detector

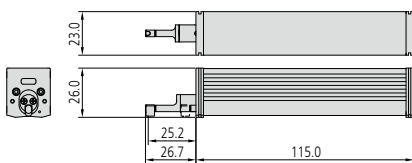

Retractable drive unit with detector

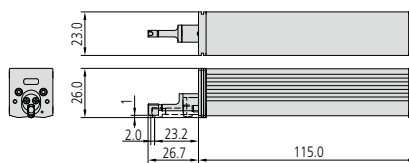

Transverse tracing drive unit with detector

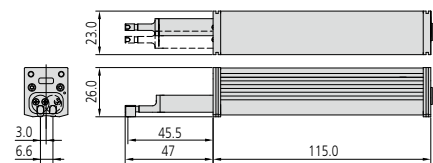

* External dimensions for the models with standard detector conforming to each drive unit.

Detector Dimensions

Standard Detectors

Unit: mm

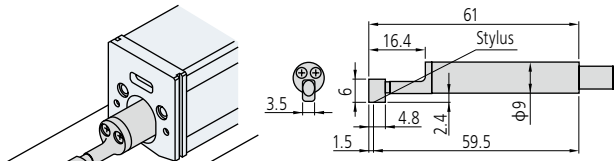

Order No.	Measuring force	Stylus form*	Remarks
178-296	0.75 mN	2 μ mR/60°	Dedicated to the standard / retractable drive unit
178-390	4 mN	5 μ mR/90°	
178-387	0.75 mN	2 μ mR/60°	Dedicated to the Transverse tracing drive unit
178-386	4 mN	5 μ mR/90°	
178-391	4 mN	10 μ mR/90°	Dedicated to the standard / retractable drive unit

* Tip radius / Tip angle

Minimum measurable hole diameter
Hole depth is less than 12 mm: ϕ 7 mm
Hole depth is 12 to 22 mm: ϕ 12 mm

Gear-tooth Surface Detectors

Unit: mm

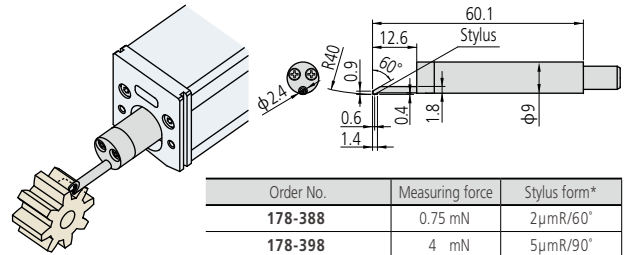

Order No.	Measuring force	Stylus form*
178-388	0.75 mN	2 μ mR/60°
178-398	4 mN	5 μ mR/90°

* Tip radius / Tip angle

Small Hole Detectors

Unit: mm

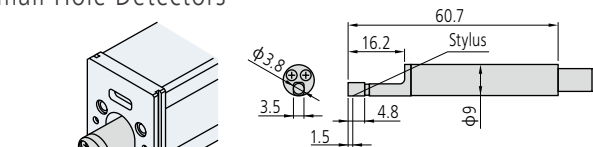

Order No.	Measuring force	Stylus form*	Remarks
178-383	0.75 mN	2 μ mR/60°	Minimum measurable hole diameter: ϕ 4.5 mm
178-392	4 mN	5 μ mR/90°	

* Tip radius / Tip angle

Deep Groove Detectors

Unit: mm

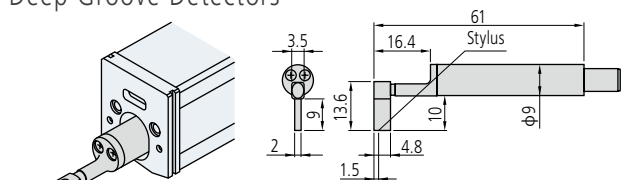

Order No.	Measuring force	Stylus form*	Remarks
178-385	0.75 mN	2 μ mR/60°	Not available for the Transverse tracing drive unit
178-394	4 mN	5 μ mR/90°	

* Tip radius / Tip angle

Extra Small Hole Detectors

Unit: mm

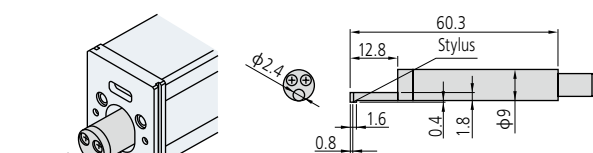

Order No.	Measuring force	Stylus form*	Remarks
178-384	0.75 mN	2 μ mR/60°	Minimum measurable hole diameter: ϕ 2.8 mm
178-393	4 mN	5 μ mR/90°	

* Tip radius / Tip angle

How to identify the stylus tip radius

Nose mounting screw (2 pcs.)

- Black: 2 μ m
- White: 5 μ m
- Yellow: 10 μ m

Custom-made for special order

Any specified detector other than above listed can be custom-made for special order. Please consult your local Mitutoyo sales office.

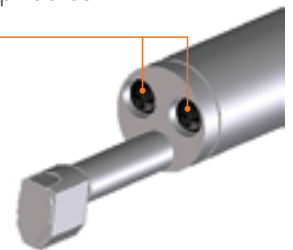

U-WAVE-TIB External Dimensions

Wireless Unit for Measuring Instrument U-WAVE-TIB

Unit: mm

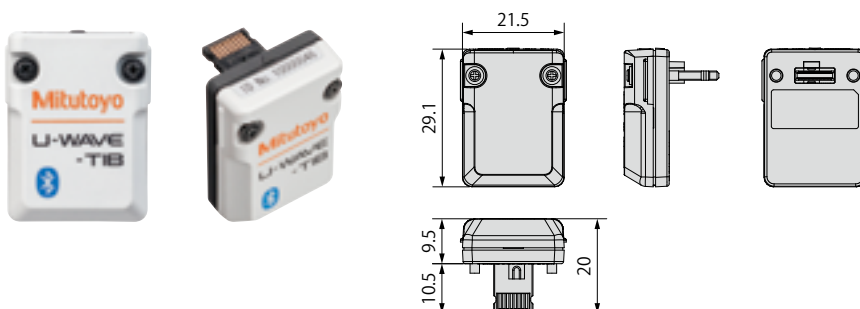

264-628

It can only be used in countries where wireless certification has been obtained, including the country of purchase. For use in countries other than the country of purchase, please contact our nearest sales office.



Whatever your challenges are, Mitutoyo supports you from start to finish.

Mitutoyo is not only a manufacturer of top quality measuring products but one that also offers qualified support for the lifetime of the equipment, backed up by comprehensive services that ensure your staff can make the very best use of the investment.

Apart from the basics of calibration and repair, Mitutoyo offers product and metrology training, as well as IT support for the sophisticated software used in modern measuring technology. We can also design, build, test and deliver measuring solutions and even, if deemed cost-effective, take your critical measurement challenges in-house on a sub-contract basis.



Find additional product literature and our product catalog

<https://www.mitutoyo.co.jp/global.html>

Notes on Export Regulations:

Do not commit an act, which could directly or indirectly, violate any law or regulation of Japan, your country or any other international treaty, relating to the export or re-export of any commodities.

Mitutoyo products are designed, manufactured and sold as industrial products that are intended for use at manufacturing sites. Mitutoyo reserves the right to change any or all aspects of any product specification, including prices, designs and service content, without notice.

Our product names, service names and logomarks used on this brochure are trademarks of Mitutoyo Corporation in Japan and other countries. Other product names and service names etc. may be trademarks or registered trademarks of their respective companies. All product information contained in this brochure is current as of Feb. 2025.

Mitutoyo

Mitutoyo Corporation

20-1, Sakado 1-Chome,
Takatsu-ku, Kawasaki-shi,
Kanagawa 213-8533, Japan
<https://www.mitutoyo.co.jp>